

Article number: 057153301824

Description: HEPCO GV3 bearing BHJ 18 DENS  
Standard for Blind hole Fixing

## Measures

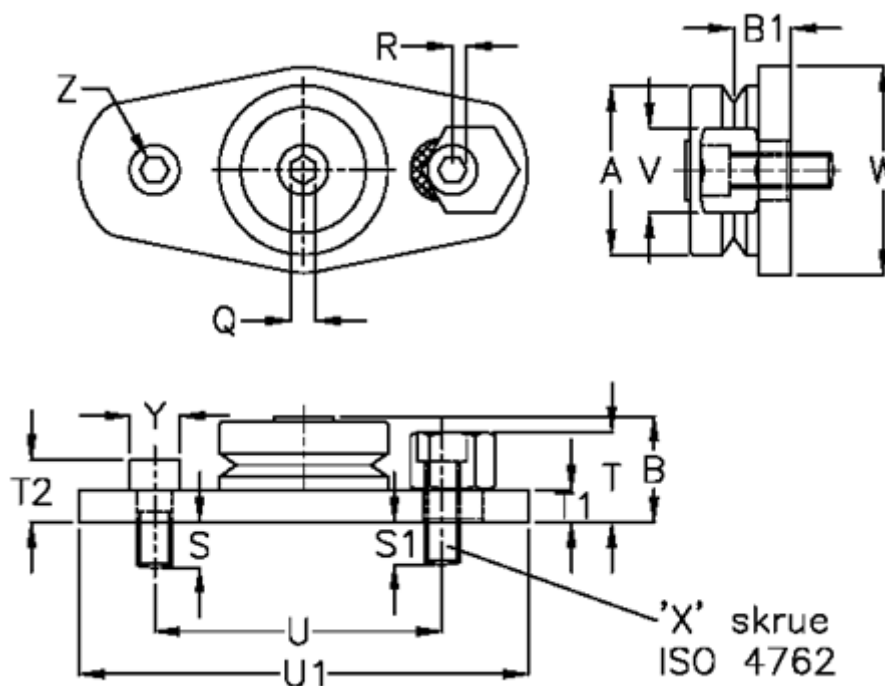

a = 18.0	T1 = 4.00	Y = 7.0
B = 12.4	T2 = 8.00	Z = 7
B1 = 6.75	U = 38.0	
Q = 2.0	U1 = 54.0	
R = 1.2	V = 11	
S = 8.00	W = 24.5	
S1 = 10.5	Weight kg/1000 = 0	
T = 10.0	X = M4	